



Pipe Valves, Fittings and Nipples

Pressures to 15,200 psi

MAXIMATOR has been designing and manufacturing high pressure equipment for more than thirty years and has a worldwide reputation for quality and reliability, backed by one of the best service organizations in the country.

Pipe Valves, Fittings and Nipples feature:

- ▶ Rising stem design.
- ▶ 316 SS (1.4404) wetted parts for excellent corrosion resistance.
- ▶ Metal-to-metal seating achieves bubble-tight shut-off, longer stem and seat life, greater durability for repeated open and close cycles.
- ▶ PTFE and carbon packing with metal back-up rings offer reliable stem to body sealing.
- ▶ Non-rotating stem prevents stem to seat galling
- ▶ Stem sleeve and packing gland materials have been selected to achieve optimum thread cycle life and reduced handle torque. All stem sleeve threads are rolled, assuring smooth operation.
- ▶ Two different valve body patterns, with choice of vee or regulating type stem tip.

MAXIMATOR offers a complete line of pipe fittings, pipe hex nipples, pipe check valves and pipe line filters. All pipe valves and fittings use the NPT connection.

Note: When selecting multiple items, the pressure rating would be that of the lowest rated component.

Index

Pipe Valves	2-3
Pipe Fittings	4-7
Pipe Hex Nipples	8
Pipe O-Ring Check Valves	9
Pipe Ball Check Valves	9
Pipe Line Filters	10

Maxpro Technologies, Inc.

7728 Klier Drive South · Fairview Pennsylvania 16415
 Phone: 814-474-9191 · Fax: 814-474-9391
 website: www.maxprotech.com

All general terms and conditions of sale, including limitations of our liability, apply to all products and services sold.
 MT R4 0218



Printed in the USA

Pipe Valves

Pressures to 15,000 psi



MAXIMATOR pipe valves with metal to metal seats have a high level of safety and reliability under adverse operating conditions. These valves may be used both with gases and liquids.

Traceability is ensured through extensively documented data (batch number, maximum pressure, material number, type designation). All pipe valves come with female national pipe threads (FNPT).

Technical Information

O.D. Size (in.)	Connection Type	Orifice Size (in.)	Rated Cv*	Pressure/Temp. Rating (psi @ R.T.)**
1/4	1/4 FNPT	0.201	0.75	15,200
3/8	3/8 FNPT	0.312	1.30	15,200
1/2	1/2 FNPT	0.312	1.30	15,200
3/4	3/4 FNPT	0.687	5.20	15,200
1	1 FNPT	0.687	5.20	15,200

Ordering Information

Typical catalog number: **15V4P071**

15V	4P	07	1	OPTIONS
Valve Series	Pipe Size	Stem Type	Body Pattern	Extreme temperature option, see below
15V	4P - 1/4" NPT 6P - 3/8" NPT 8P - 1/2" NPT 12P - 3/4" NPT 16P - 1" NPT	07 - VEE stem 08 - REGULATING stem	1 - two-way straight 2 - two-way angle	

Special Designs for Extreme Temperatures

Standard valves are supplied with Teflon/Carbon packing and may be operated to 450°F. Consult **MAXPRO** for higher temperature packing ratings.

- **TG** standard valve with Teflon glass packing to 600°F.
- **B** standard valve with cryogenic trim materials and Teflon packing to -100°F.

Repair Kits

Consult your **MAXPRO** representative for repair kits and valve bodies. Refer to the Tools and Installation section for proper maintenance procedures.

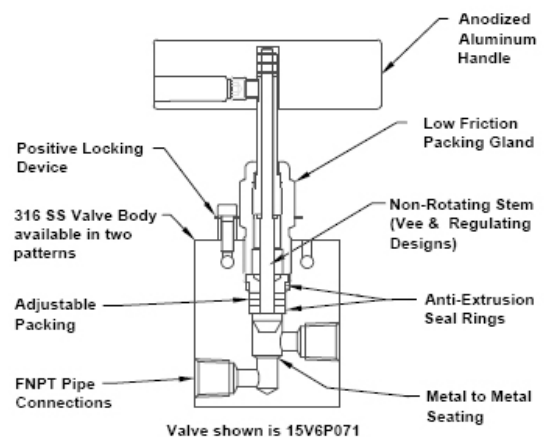
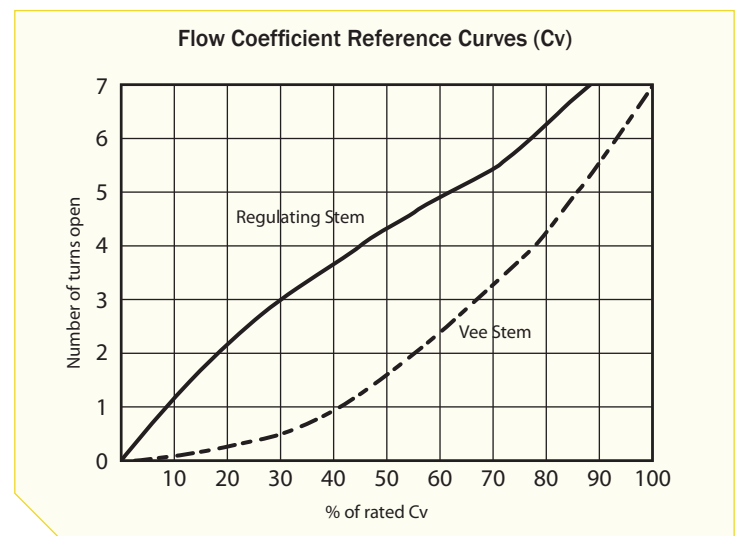

* Cv values shown are for 2-way straight pattern vee stem valves, for 2-way angle patterns, increase the Cv value by 50%.

**See page 2 in the Technical Section for Pressure/Temperature Rating Chart.

All general terms and conditions of sale, including limitations of our liability, apply to all products and services sold.
MT R4 0218

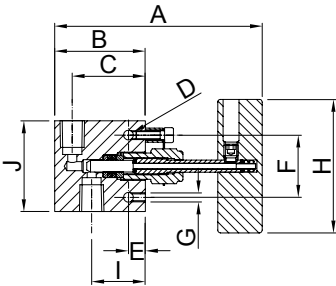
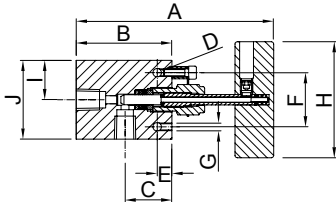
Valve Pattern	Catalog Number	Stem Type	Pipe Size (in.)	Orifice (in.)	Dimensions (in.)									Valve Panel Hole	Block Thickness
					A	B	C	D	E	F	H	I	J		
2-Way Straight															
	15V4P071	Vee	1/4	0.201	4.61	2.01	1.62	0.22	0.37	1.24	2.95	1.19	2.01	0.75	0.79
	15V4P081	Reg													
	15V6P071	Vee	3/8	0.312	6.35	2.88	2.38	0.37	0.45	1.38	3.94	1.75	2.50	1.00	1.02
	15V6P081	Reg													
	15V8P071	Vee	1/2	0.312	6.49	3.11	2.36	0.37	0.45	1.38	3.94	1.73	2.64	1.00	1.54
	15V8P081	Reg													
	15V12P071	Vee	3/4	0.687	9.00	4.65	3.75	0.53	1.13	2.50	10.31	2.81	4.13	1.62	1.77
	15V12P081	Reg													
	15V16P071	Vee	1	0.687	9.00	4.65	3.75	0.53	1.13	2.50	10.31	2.81	4.13	1.62	1.77
	15V16P081	Reg													
2-Way Angle															
	15V4P072	Vee	1/4	0.201	5.00	2.43	1.19	0.22	0.37	1.24	2.95	1.00	2.01	0.75	0.79
	15V4P082	Reg													
	15V6P072	Vee	3/8	0.312	6.77	3.38	1.75	0.38	0.45	1.38	3.94	1.25	2.50	1.00	1.02
	15V6P082	Reg													
	15V8P072	Vee	1/2	0.312	6.49	3.11	1.73	0.37	0.45	1.38	3.94	1.32	2.64	1.00	1.54
	15V8P082	Reg													
	15V12P072	Vee	3/4	0.687	9.00	4.65	2.81	0.53	1.13	2.50	10.31	2.07	4.13	1.62	1.77
	15V12P082	Reg													
	15V16P072	Vee	1	0.687	9.00	4.65	2.81	0.53	1.13	2.50	10.31	2.07	4.13	1.62	1.77
	15V16P082	Reg													

G - Panel mounting screw thread size 10-24 UNC.
All dimensions are for reference only and are subject to change.

Pipe Fittings

Pressures to 15,200 psi



MAXIMATOR pipe fittings are designed for liquid and gas applications. The P Series Fittings are available from 1/4" to 1" NPT to 15,200 psi.

NPT threads must be sealed using a high quality PTFE tape and/or paste product. Sealing performance may vary based on many factors such as pressure, temperature, media, thread quality, thread material, proper thread engagement and proper use of thread sealant.

MAXIMATOR recommends to limit the number of times an NPT fitting is assembled and disassembled because thread deformation during assembly will result in deteriorating seal quality over time. When using only PTFE tape, using thread lubrication to prevent galling of mating parts is recommended.



Fitting Pattern	Catalog Number	Connection Type	Orifice (in)	Dimensions (in.)							Block Thickness
				A	B	C	D	E	F	G	
Pipe Elbow											
	15L4P	1/4" NPT	0.201	0.75	1.14	1.54	0.75	0.49	0.49	0.22	0.79
	15L6P	3/8" NPT	0.312	1.00	1.50	2.01	1.00	0.63	0.63	0.26	1.02
	15L8P	1/2" NPT	0.312	1.50	1.89	2.99	1.25	0.84	1.08	0.33	1.38
	15L12P	3/4" NPT	0.685	1.50	2.24	2.99	1.50	1.00	1.00	0.35	1.38
	15L16P	1" NPT	0.685	2.07	2.52	4.13	1.57	1.10	1.38	0.53	1.77
Pipe Tee											
	15T4P	1/4" NPT	0.201	0.77	1.14	1.54	0.75	0.49	1.02	0.22	0.79
	15T6P	3/8" NPT	0.312	1.00	1.50	2.01	1.00	0.63	1.26	0.26	1.02
	15T8P	1/2" NPT	0.312	1.50	1.89	2.99	1.26	0.87	2.00	0.35	1.38
	15T12P	3/4" NPT	0.685	1.50	2.20	2.99	1.50	1.00	2.00	0.35	1.38
	15T16P	1" NPT	0.685	2.07	2.52	4.13	1.57	1.10	2.76	0.53	1.77

See page 2 in the Technical Section for pressure/temperature rating chart.

Note: All dimensions for reference only and are subject to change.

All general terms and conditions of sale, including limitations of our liability, apply to all products and services sold.
MT R4 0218

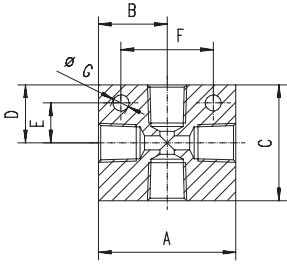
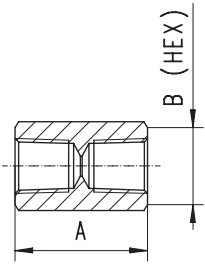
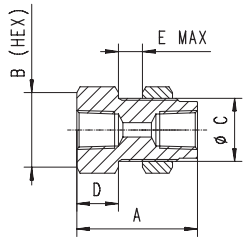
Fitting Pattern	Catalog Number	Connection Type	Orifice (in)	Dimensions (in.)							Block Thickness
				A	B	C	D	E	F	G	
Pipe Cross											
	15X4P	1/4" NPT	0.201	1.54	0.77	1.54	0.77	0.49	0.98	0.22	0.79
	15X6P	3/8" NPT	0.312	2.01	1.00	2.01	1.00	0.63	1.26	0.26	1.02
	15X8P	1/2" NPT	0.312	2.99	1.50	2.52	1.26	0.87	2.01	0.35	1.38
	15X12P	3/4" NPT	0.685	2.99	1.50	2.99	1.50	1.00	2.01	0.35	1.38
	15X16P	1" NPT	0.685	4.13	2.07	3.15	1.57	1.10	2.76	0.53	1.77
Pipe Coupling											
	15F4P	1/4" NPT	0.201	1.50	0.81						
	15F6P	3/8" NPT	0.312	1.63	1.06						
	15F8P	1/2" NPT	0.312	2.05	1.19						
	15F12P	3/4" NPT	0.685	2.72	1.44						
	15F16P	1" NPT	0.685	2.52	2.00						
Pipe Bulkhead Coupling											
	15BF4P	1/4" NPT	0.201	2.00	1.06	0.9	0.63	0.71			
	15BF6P	3/8" NPT	0.312	2.38	1.44	1.14	0.79	0.63			
	15BF8P	1/2" NPT	0.312	2.63	1.63	1.39	0.91	0.63			
	15BF12P	3/4" NPT	0.685	2.63	2.00	1.69	0.91	0.47			
	15BF16P	1" NPT	0.685	3.50	2.00	1.97	1.50	0.39			

See page 2 in the Technical Section for pressure/temperature rating chart.
All dimensions are for reference only and are subject to change.

Pipe Fittings

Pressures to 15,200 psi

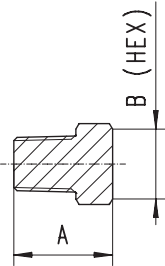
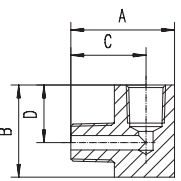
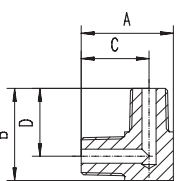
Fitting Pattern	Catalog Number	Connection Type	Orifice (in)	Dimensions (in.)							Block Thickness
				A	B	C	D	E	F	G	
Pipe Plugs											
	15P4P	1/4" NPT		1.10	0.69						
	15P6P	3/8" NPT		1.10	0.88						
	15P8P	1/2" NPT		1.50	1.06						
	15P12P	3/4" NPT		1.50	1.44						
	15P16P	1" NPT		1.89	1.44						
Street Pipe Elbow											
	15SPL4P	1/4" NPT	0.201	1.50	1.50	1.13	1.00				0.79
	15SPL6P	3/8" NPT	0.312	1.76	1.50	1.25	1.00				1.02
	15SPL8P	1/2" NPT	0.312	2.25	2.00	1.63	1.25				1.02
	15SPL12P	3/4" NPT	0.685	2.5	2.62	1.81	1.70				1.54
	15SPL16P	1" NPT	0.685	2.99	2.99	2.13	2.01				1.77
Male Pipe Elbow											
	15MPL4P	1/4" NPT	0.201	1.50	1.50	1.13	1.13				0.79
	15MPL6P	3/8" NPT	0.312	1.75	1.75	1.25	1.25				1.02
	15MPL8P	1/2" NPT	0.312	2.00	2.00	1.47	1.47				1.02
	15MPL12P	3/4" NPT	0.685	2.62	2.62	1.87	1.87				1.54
	15MPL16P	1" NPT	0.685	2.99	2.99	2.13	2.13				1.77

See page 2 in the Technical Section for pressure/temperature rating chart.

Note: All dimensions for reference only and are subject to change.

All general terms and conditions of sale, including limitations of our liability, apply to all products and services sold.
MT R4 0218

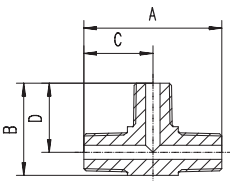
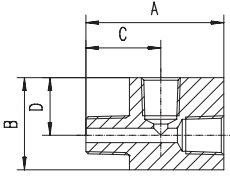
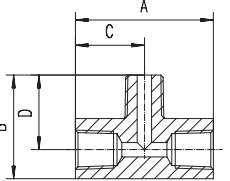
Fitting Pattern	Catalog Number	Connection Type	Orifice (in)	Dimensions (in.)							Block Thickness
				A	B	C	D	E	F	G	
Male Pipe Tee											
	15MPT4P	1/4" NPT	0.201	2.26	1.50	1.13	1.13				0.79
	15MPT6P	3/8" NPT	0.312	2.50	1.75	1.25	1.25				1.02
	15MPT8P	1/2" NPT	0.312	3.00	2.00	1.50	1.50				1.02
	15MPT12P	3/4" NPT	0.685	3.50	2.62	1.75	1.77				1.54
	15MPT16P	1" NPT	0.685	4.13	2.99	2.07	2.13				1.77
Street Pipe Tee											
	15SPT4P	1/4" NPT	0.201	2.00	1.38	1.15	1.00				0.79
	15SPT6P	3/8" NPT	0.312	2.50	1.50	1.50	1.00				1.02
	15SPT8P	1/2" NPT	0.312	3.00	2.00	1.63	1.25				1.26
	15SPT12P	3/4" NPT	0.685	3.15	2.62	1.85	1.70				1.54
	15SPT16P	1" NPT	0.685	4.13	2.99	2.13	2.13				1.77
Male Branch Tee											
	15BPT4P	1/4" NPT	0.201	2.00	1.50	1.00	1.13				0.79
	15BPT6P	3/8" NPT	0.312	2.00	1.75	1.00	1.25				1.02
	15BPT8P	1/2" NPT	0.312	3.00	2.25	1.50	1.62				1.26
	15BPT12P	3/4" NPT	0.685	3.00	2.62	1.50	1.87				1.54
	15BPT16P	1" NPT	0.685	4.13	2.99	2.07	2.13				1.77

Pipe Hex Nipples

Pressures to 15,200 psi



MAXIMATOR Pipe Hex Nipples are designed for rapid system make-up. They are available in various lengths for pipe valves and fittings.

In addition to the minimum lengths (Pipe Hex Close Nipples) and standard lengths listed in the table below, Pipe Hex Nipples are also available in custom lengths. Please consult factory.



Fitting Pattern	Catalog Number	Connection Type	Working Pressure (psi)	Orifice in.	Dimensions (in.)	
					A	B
Pipe Hex Close Nipple						
	15M4P	1/4" NPT	15,200	0.201	1.85	0.69
	15M6P	3/8" NPT	15,200	0.312	1.89	0.88
	15M8P	1/2" NPT	15,200	0.312	2.50	1.06
	15M12P	3/4" NPT	15,200	0.685	2.81	1.44
	15M16P	1" NPT	15,200	0.685	3.19	1.44
Pipe Hex Close Nipple						
	15M4P-4	1/4" NPT	15,200	0.201	4.00	0.69
	15M4P-6				6.00	
	15M4P-8				8.00	
	15M6P-4	3/8" NPT	15,200	0.312	4.00	0.88
	15M6P-6				6.00	
	15M6P-8				8.00	
	15M8P-4	1/2" NPT	15,200	0.312	4.00	1.06
	15M8P-6				6.00	
	15M8P-8				8.00	
	15M12P-4	3/4" NPT	15,200	0.685	4.00	1.44
	15M12P-6				6.00	
	15M12P-8				8.00	
	15M16P-4	1" NPT	15,200	0.685	4.00	1.44
	15M16P-6				6.00	
	15M16P-8				8.00	

Note: All dimensions for reference only and are subject to change.

See page 2 in the Technical Section for pressure/temperature rating chart.

All general terms and conditions of sale, including limitations of our liability, apply to all products and services sold.
MT R4 0218

Pipe O-Ring Check Valves



MAXIMATOR pipe o-ring check valves provide high quality directional flow control and bubble tight shutoff for liquids and gases. These check valves are not to be used as a relief device. The opening pressure of the o-ring check valves is approximately 10 psi.

Materials:

Body, cover, poppet, cover gland: 316 series stainless steel
Spring: 300 series stainless steel
O-ring: Viton "A" (-4 °F to 392 °F)*

Pipe Ball Check Valves



MAXIMATOR Pipe ball check valves prevent reverse flow where bubble tight shutoff is not mandatory. These check valves are designed to operate to 660 °F. These check valves are not to be used as a relief device. The opening pressure of the pipe ball check valves is approximately 10 psi.

Materials:

Body, cover, poppet, cover gland: 316 series stainless steel
Ball: 316 series stainless steel
Spring: 300 series stainless steel

Valve Pattern	Catalog Number	Pressure Rating (psi)	Connec-tion Type	Orifice (in.)	Rated (Cv)	Dimensions (in.)			
						A	B	C (Hex)	D(Hex)
Pipe O-Ring Check Valves									
	150C4P	15,200	1/4" NPT	0.201	0.28	3.36	2.40	0.88	0.88
	150C6P	15,200	3/8" NPT	0.312	0.84	3.94	2.95	1.44	1.44
	150C8P	15,200	1/2" NPT	0.312	2.30	5.30	3.90	1.44	1.44
	150C12P	15,200	3/4" NPT	0.685	4.70	6.29	4.88	2.00	2.00
	150C16P	15,200	1" NPT	0.685	7.40	7.32	5.75	2.00	2.00
Pipe Ball Check Valves									
	15BC4P	15,200	1/4" NPT	0.201	0.28	3.36	2.40	0.88	0.88
	15BC6P	15,200	3/8" NPT	0.312	0.84	3.94	2.95	1.44	1.44
	15BC8P	15,200	1/2" NPT	0.312	2.30	5.32	3.90	1.44	1.44
	15BC12P	15,200	3/4" NPT	0.685	4.70	6.29	4.88	2.00	2.00
	15BC16P	15,200	1" NPT	0.685	7.40	7.32	5.75	2.00	2.00

CAUTION: FREQUENT INSPECTIONS of O-Rings are necessary to ensure proper service of the check valve. O-Rings have shown satisfactory service life in testing, however different service conditions may lead to variations in cycle and shelf life.

All dimensions are for reference only and subject to change.

*See page 2 in the Technical Section for determining operating pressures above room temperature.

Pipe Line Filters

Pressures to 15,200 psi

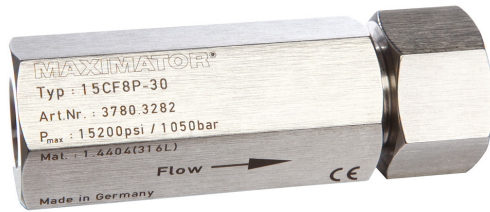

MAXIMATOR pipe line filters are used to filter process fluids in high pressure systems. The cup type design is used when maximum filtration surface area and a single micron size element is preferred. This design increases the filter area as much as 6 times the area of the disc type filter, and will permit higher flow rates with a lower pressure drop, and longer intervals between element changes. Filter elements come standard in: 5, 30 or 56 micron sizes and are easily replaced. Filters are rated for temperatures -60° F to 660° F.

Materials:

Body, cover, cover gland: 316 series stainless steel

Element: 300 series stainless steel

Valve Pattern	Catalog Number	Pressure Rating (psi)	Connec-tion Type	Orifice (in.)	Micron size	Filter Element Area (in)	Dimensions (in.)			
							A	B	C (Hex)	D(Hex)
Pipe Line Filters										
	15CF4P-5	15,200	1/4" NPT	0.201	5	0.82	3.25	2.36	0.88	0.88
	15CF4P-30				30					
	15CF4P-56				56					
	15CF6P-5	15,200	3/8" NPT	0.394	5	1.55	3.69	2.83	1.19	1.44
	15CF6P-30				30					
	15CF6P-56				56					
	15CF8P-5	15,200	1/2" NPT	0.394	5	1.55	4.42	3.35	1.44	1.44
	15CF8P-30				30					
	15CF8P-56				56					
	15CF12P-5	15,200	3/4" NPT	0.685	5	6.14	6.57	5.12	2.00	2.00
	15CF12P-30				30					
	15CF12P-56				56					
	15CF16P-5	15,200	1" NPT	0.685	5	6.14	6.77	5.31	2.00	2.00
	15CF16P-30				30					
	15CF16P-56				56					

It is recommended that all fluids entering a high pressure system be thoroughly cleaned.

Maximator filters are designed to remove small amounts of process particles.

Pressure differential should not exceed 1000 psi across the filter elements.

All dimensions are for reference only and subject to change.